

ATTENTION : Il existe 2 configurations au niveau de l'arbre de transmission et des joints d'étanchéité associés. Choisir parmi les repères 11 à 13 ou 15 à 18, selon la hauteur des **plats d'entraînement** de l'arbre de transmission sur votre machine.
 $h = 18,5 \text{ mm}$; $H = 25,5 \text{ mm}$

WARNING : There are 2 configurations regarding the transmission shaft and the associated seals. Choose among indexes 11 to 13 or 15 to 18, according to the height of the transmission shaft **driving flats** on your machine.

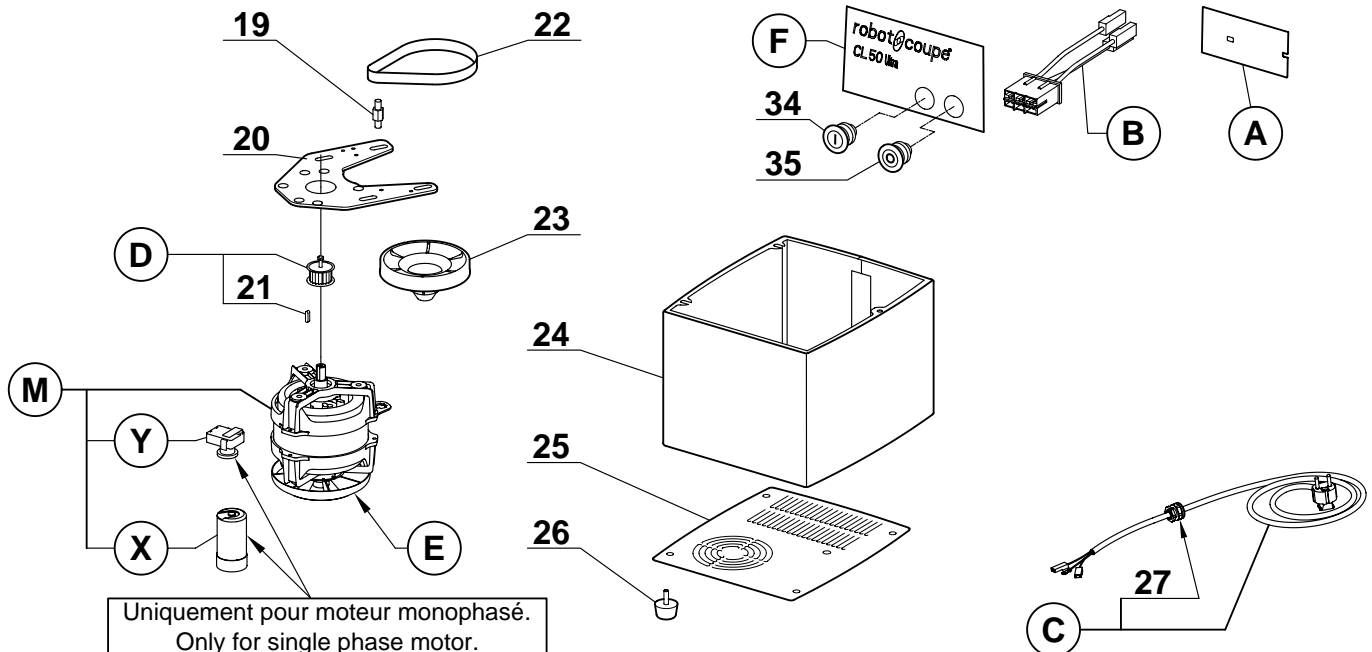
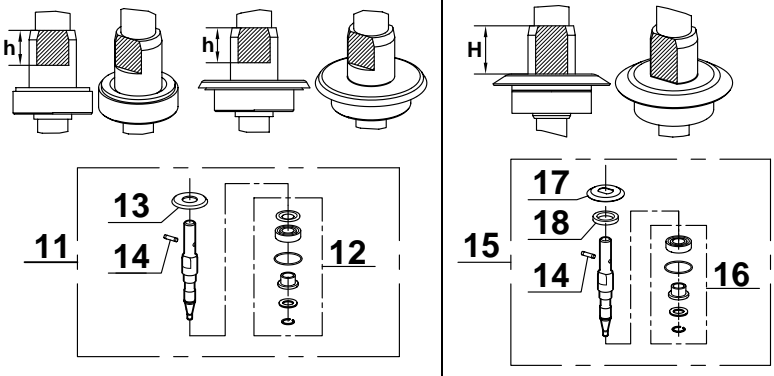

Uniquement pour moteur monophasé.
 Only for single phase motor.